

P25 with DC coil

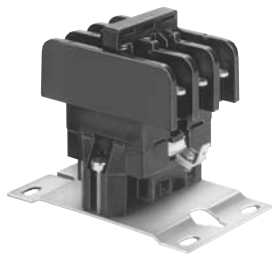

P25 with AC coil

P25 series

Definite Purpose Magnetic Contactor 25 Ampere Full Load 30 Ampere Resistive AC & DC Coils

File E22575

File LR15734

Users should thoroughly review the technical data before selecting a product part number. It is recommended that users also seek out the pertinent approvals files of the agencies/laboratories and review them to ensure the product meets the requirements for a given application.

Features

- AC and DC coils.
- For controlling motors, power supplies, heating elements and lighting.
- Dust cover available.
- Auxiliary switch available.

Contact Data @ 25°C

Arrangements: Up to 3 Form X (3PST-NO-DM).

Ratings: See contact rating table.

Material: Silver-cadmium oxide.

Expected Life: 200,000 operations at full load.

AC coil: 2 million operations, mechanical.

DC coil: 5 million operations, mechanical.

Minimum Contact Load: 3A @ 120VAC.

Coil Data

Nominal VDC	Resistance (Ohms ± 10% @ 25°C)	Must Operate* Volts	Maximum Operating Volts	Nominal Coil Current (ma) @ Nominal Voltage
12	34	9	15	353
24	133	18	30	180

AC Voltage Rating	Nominal		Must Operate	
	60 Hz.	50 Hz.	60 Hz.	50 Hz.
24	24	24	20.4	20.4
120	120	110	102	94
240	208/240	208/220	177	177

Consult factory for other voltages.

*Must operate is 75% of nominal voltage for any mounting position, applicable for vertical or horizontal mounting, but not for upside-down mounting.

**Units requiring less power can be provided for some applications.

Consult factory for details.

Note: Coil suppression is recommended for all DC coil units, particularly 120 and 240VDC coils.

Main Contact Ratings @ +25°C, 60 Hz.

Type	Motor Rating in Amps, 3Ø3P or 1Ø2P				Resistive Rating (Electric Heat) @ 600V
	Full Load @ 600V	Locked Rotor			
		@ 240V	@ 480V	@ 600V	
P25	25A	150A	125A	100A	30A

Type	Motor Rating in Horsepower		
	@ 120V	@ 240V	@ 440-600V
1Ø2P	1.5HP	3HP	—
3Ø3P	3HP	7.5HP	10HP

Notes: Models utilizing box lug terminals are restricted to the following ratings: 25 FLA, 150 LRA @ 250VAC, 30A @ 277VAC Resistive; Horsepower ratings shown in the table are valid up to 240VAC.

Tungsten Lamp Rating: 30A, 277VAC.

Electric Discharge Lamp Rating: 30A, 277VAC.

Heavy Duty Pilot Ratings @ 120V through 600V: 720VA max. (Box lug nut units limited to 277VAC.)

Auxiliary Snap-Action Switch

Arrangements: Up to 2 Form C (DPDT).

Rating: 10 amps at 120VAC, 60 Hz. @ 25°C.

Material: Silver.

Initial Dielectric Strength

Initial Breakdown Voltage: 2,200V rms. minimum between all elements and between all elements and ground.

Coil Data @ 25°C

Voltage: From 6 to 240VDC and 24 to 600VAC, 50/60 Hz.

Power: DC, 4-8W; AC, 40VA inrush; 10VA, sealed.

Duty Cycle: Continuous.

Insulation Class: Class A, standard. Class B available.

Initial Insulation Resistance: 100 megohms, minimum.

Operate Data @ 25°C

Must-Operate Voltage: See coil data tables.

Environmental Data

Temperature Range: AC: -55°C to +65°C

DC: -55°C to +55°C

Contact sales representative for higher temperature ratings.

Mechanical Data

Mounting: No. 10 screws on 2.125" (53.98mm) centers or universal mounting bracket.

Termination:

Contacts: 8-32 screw for No. 16 to No. 8 wire, dual .250" (6.35mm) quick connect, box lug or captive pressure plate.

Coil: Combination 8-32 screw and .250" (6.35mm) or .187" (4.75mm) quick connect, combination captive pressure plate and .250" (6.35mm) quick connect, or .250" (6.35mm) quick connect.

Aux. Switch: .187" (4.75mm) quick connect.

Weight: 14 oz. (397g).

Ordering Information

Typical Part No. ▶	P25	P	42	A	1	4	P	1	-240
1. Type: P25 Definite Purpose Contactor									
2. Auxiliary Switch: P = No Aux Switch C = 1 Form C (SPDT), silver contacts F = 2 Form C (DPDT), silver contacts Double pole contact forms require two switches.									
3. Main Contact Arrangement: 42 = 3 Form X (3PST-NO-DM) 43 = 2 Form X (DPST-NO-DM) & 1 Form Y (SPST-NC-DB) Other contact arrangements are available.									
4. Coil Control Input: A = Alternating Current, 50/60 Hz. D = Direct Current									
5. Mounting and Installed Accessories: 1 = Without Mounting Plate* 2 = With Mounting Plate * Order separately any mounting hardware which is to be bulk packed.									
6. Main Contact Terminals: 2 = 8-32 Screw Terminals 3 = Dual .250" (6.35mm) Quick Connect 5 = 8-32 Screw with Captive Pressure Plate									
7. Auxiliary Contact Terminals: P = No Auxiliary Switch C = .187" (4.75mm) Quick Connect									
8. Coil Terminals: 1 = Combination 8-32 Screw Terminal and .250" (6.35mm) Quick Connect 6-32 Screw Terminal available on DC Coils only.									
9. Coil Voltage: 24, 120 or 240VAC 12 or 24VDC See Coil Data table.									

Our authorized distributors are more likely to maintain the following items in stock for immediate delivery.

- P25P42A12P1-120
- P25P42A12P1-240
- P25P42A22P1-120
- P25P42A22P1-240
- P25P42D22P1-12
- P25P42D22P1-24

Outline Dimensions

P25 With AC Coil

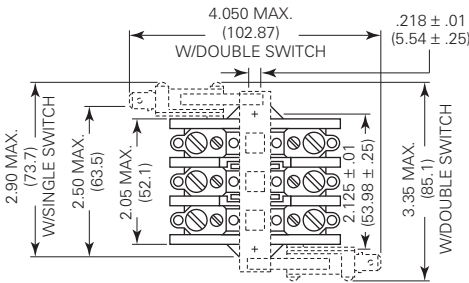

P25 With DC Coil

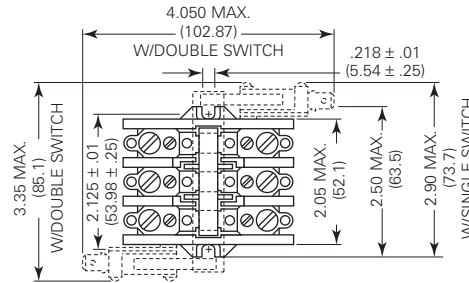

Mounting Plate Footprint

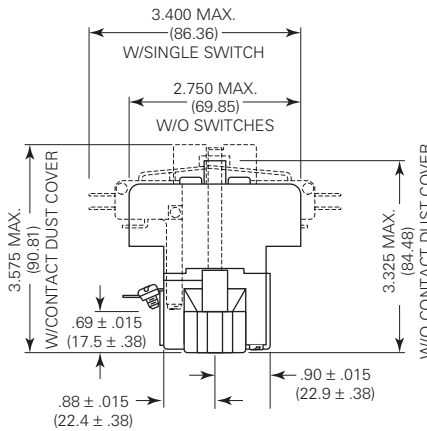
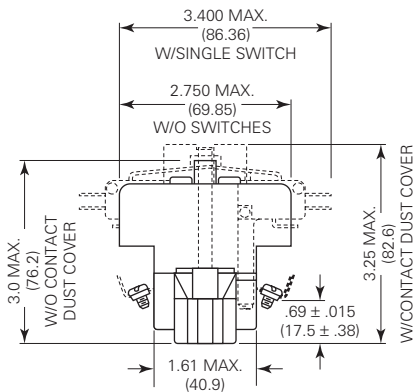
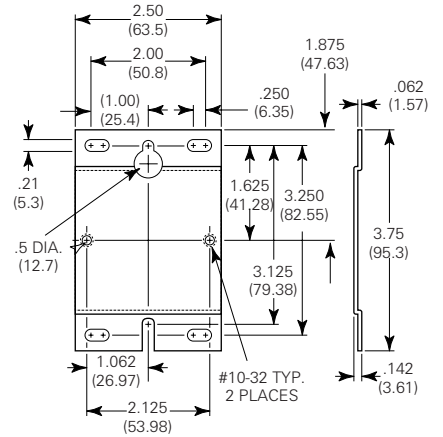

Contact Terminal Options

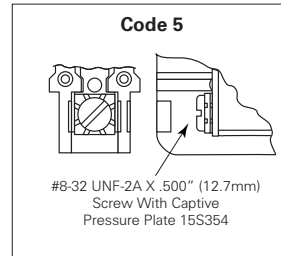
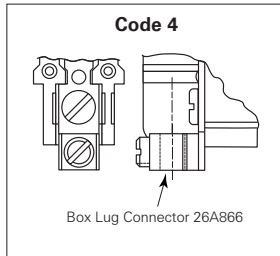
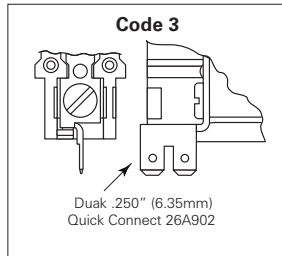
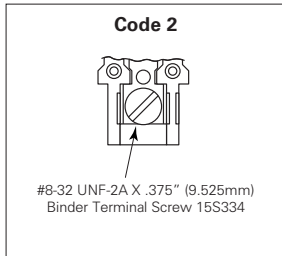

Replacement Parts and Accessories

Contact Replacement Kit - 9P25X1

Contact replacement kit includes 3 contact pressure springs, 3 movable contact assemblies and 6 stationary contact assemblies. Contact replacement kits are for use only on those models with form X contact arrangements.

Mounting Plate Kit - 9P25X2

Mounting plate kit includes one mounting plate (37B918) and two mounting screws (15J011).

Auxiliary Switch Kit for P25 AC Coil Units - 9P25X3

This auxiliary switch kit includes one plastic actuator and one auxiliary switch assembly. It contains no screw. One assembly screw must be removed from the P25 contactor and used to mount the auxiliary switch.

Auxiliary Switch Kit for P25 DC Coil Units - 9P25X4

This auxiliary switch kit includes one plastic actuator, one auxiliary switch assembly and one thread cutting screw.